

## ■ GECKO | COMPACT WELDING TRACTOR

Gecko is a portable mini fillet welder designed to produce consistent high-quality welds.

It features 4-wheel drive system with magnetic traction and a control loop feedback mechanism which provides speed stabilization in all welding positions.

Constant, continuous and repeatable travel speed enables weld bead geometry that is exact to the required specifications, thus reducing costly over welding and decreasing filler metal usage, substantially.

Lots of optional accessories make Gecko fit for a specific use including cutting and welding of stainless steel constructions.

GECKO compact welding tractor weighs only 8 kg (17 lbs).



### ■ Applications:

- Trailer manufacturing
- Truck tanks
- Oil tanks
- Water storage tanks
- Transformers
- Shipyards
- Any application demanding a long, continuous fillet weld











#### **GECKO HS (High Speed)**

New special version for specific applications is available now

#### **GECKO HS (High Speed)**

with increased horizontal speed up to 220 cm/min (86.6 in/min) is suitable for both speed welding and plasma cutting

-  Continuous welding
-  Dual torch welding
-  Horizontal speed 0-110 cm/min  
(0-43.3 in/min)
-  Vertical speed 0-100 cm/min  
(0-39.4 in/min)
-  Dual Arc Ignition
-  Min. path convex radius 1000 mm (3.5 ft)
-  Min. path concave radius 1000 mm (3.5 ft)
-  Weight 8 kg (18 lbs)

Versatility of Gecko welding tractor applications including out-of-position use

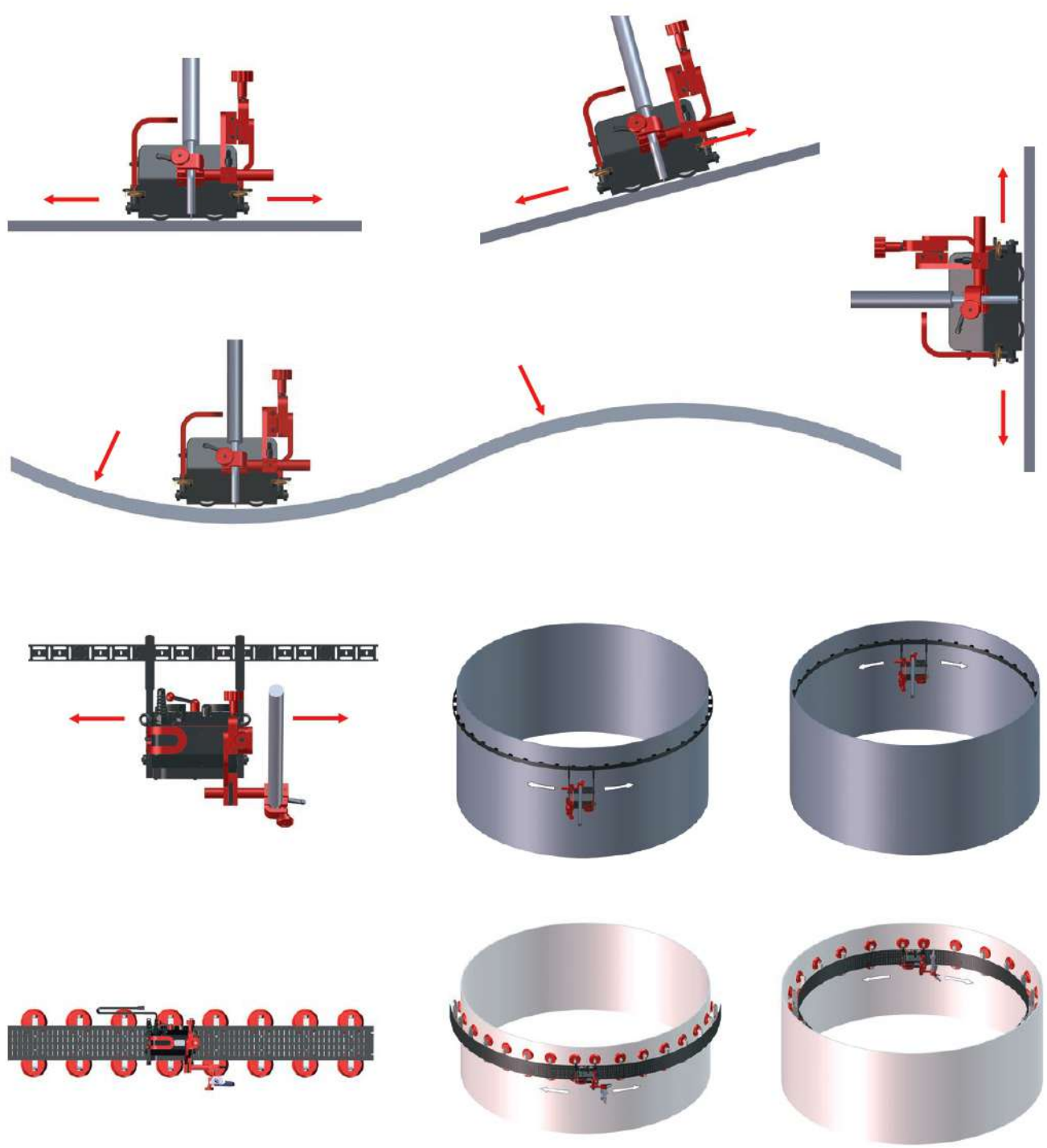

## ■ Primary features and benefits of Gecko welding tractor:

- Compact, lightweight design with durable aluminum cast housing
- Convenient Power Supply 115-230 V, 50-60 Hz or 42 V, 50-60 Hz
- Positive magnetic traction permits out of position use
- Magnet on/off lever permits easy set up and adjustment on work piece
- Maintenance free 4-wheel drive with worm gear reduction
- Heat resistant silicone wheels
- Quick clamping Torch Holder mechanism for different types of MIG/MAG torches with diameters of 16-22 mm (5/8" - 7/8"); optionally up to 35 mm (1-3/8")
- Precise torch adjustment with screw drive cross slide
- Multifunctional LED display - presetting of travel speed, error codes information
- Closed loop speed control system stabilizes travel speed to reduce weld defects and costly rework
- Consistent heat input reduces distortion
- Reduced wasted filler metal - eliminates over welding
- Automatic arc on/off system initiates welding with travel, simultaneously
- Capable of carrying and controlling 2 torches
- Self-guiding roller arms eliminate the need for track
- Multi-surface guiding with user-friendly adjustment of tractor position
- Improves working environment - removes operator from heat and fumes
- Plasma cutting possible

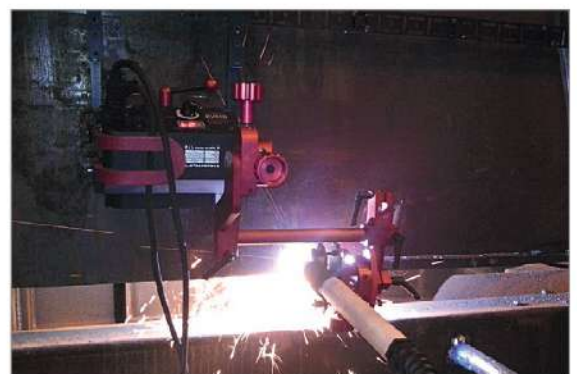

TECHNICAL SPECIFICATIONS	GECKO	GECKO HS
Voltage	1~ 115-230 V, 50-60 Hz 42 V, 50-60 Hz	1~ 115-230 V, 50-60 Hz 42 V, 50-60 Hz
Power	20 W	20 W
Welding position (according to EN ISO 6947 and AWS/ASME)	PA / 1F / 1G PB / 2F PC / 2G PD / 4F PE / 4G PG / 3F / 3G (contact dealer)	PA / 1F / 1G PB / 2F PC / 2G PD / 4F PE / 4G
Torch diameter	16-22 mm (0.63-0.87"); up to 35 mm (1.38") option	16-22 mm (0.63-0.87"); up to 35 mm (1.38") option
Minimum radius of curved workpiece surface	1000 mm (3.5 ft)	1000 mm (3.5 ft)
Minimum workpiece thickness	4 mm (0.16")	4 mm (0.16")
Ground clearance	4 mm (0.16")	4 mm (0.16")
Horizontal pulling force	150 N	150 N
Vertical pulling force	100 N	N/A
Cross slide adjustment range	0-35 mm (0-1.38") up down, left-right	0-35 mm (0-1.38") up down, left-right
Horizontal speed	0-110 cm/min (0-43.3 in/min)	5-220 cm/min (1.5-86.6 in/min)
Vertical speed	0-100 cm/min (0-39.4 in/min)	N/A
Weight	8 kg (18 lbs)	8 kg (18 lbs)
Welding settings storage	1 (last used)	1 (last used)
Product Code (115-230 V, 50-60 Hz, plug EU)	WOZ-0466-10-20-00-0	WOZ-0528-10-20-00-0
Product Code (115-230 V, 50-60 Hz, plug UK)	WOZ-0466-10-10-00-0	WOZ-0528-10-10-00-0
Product Code (42 V, 50-60 Hz)	WOZ-0621-10-04-00-0	WOZ-0622-10-04-00-0

### Dimensions:

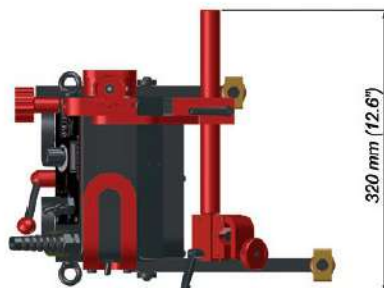
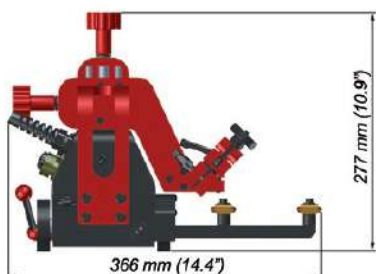

1. Drive unit with control panel
2. Magnetic adhesion release lever
3. Weld contact / Arc ignition socket
4. Power supply coupling
5. Adjustable guide arm
6. Quick clamp torch holder
7. Main power switch (0/1)
8. Cross slide assembly



The newest improved guide arms family makes a proper welding tractor positioning even easier.

- 7 different guide types are dedicated to various welding applications and positions
- include a number of fixing grooves for your convenience
- enable simpler, easier and more consistent adjustment of how guide arms stick out
- secure proper tilting of the tractor into a direction of its movement
- maintain a permanent contact with the workpiece
- allow either interval or continuous guide arms adjustment

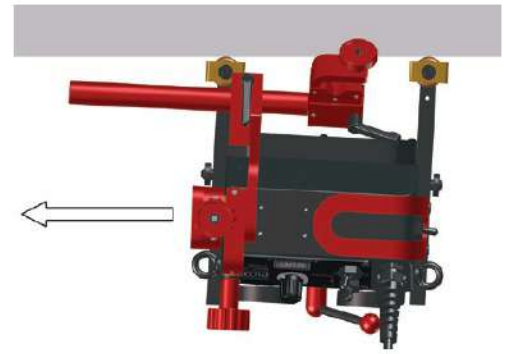

Each new guide arm has got a number of indented grooves only on one side.

All types of guide arms are available in pairs of 2 pcs: right and left.



Interval adjustment of a degree how much the guide arms stick out



Continuous adjustment of a degree how much the guide arms stick out

## Standard accessories



PRW-0466-67-00-00-0  
Standard guide arms (set of 2 pcs)



KBL-0466-17-00-00-0  
Dual arc ignition cable of 6.5 m (21 ft)



UCW-0466-04-00-00-0 Torch Holder  
Long Rod Clamp Assembly



PWD-0466-18-00-00-0 (230 V CEE)  
PWD-0466-16-00-00-0 (115 V USA)  
PWD-0466-23-00-00-0 (115 V UK)  
Power cord 3 m (10 ft)



**Optional accessories for variety of applications**

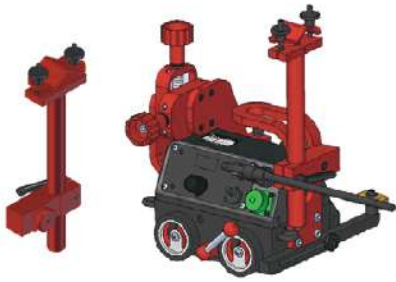

PDT-0466-55-00-00-0  
Cable anchor



ZSP-0466-46-00-00-1  
Extended cross-slide  
0-76 mm (0-3") up-down,  
0-35 mm (0-1.38") left-right



PRD-0466-43-00-00-0  
Torch Extension Arm



URZ-000001  
Fall arrester device



OSL-0466-29-00-00-0  
Display shield



KOL-0466-72-00-00-0  
Stainless steel driving wheel



PDT-0466-40-00-00-0  
Dual Torch Mount

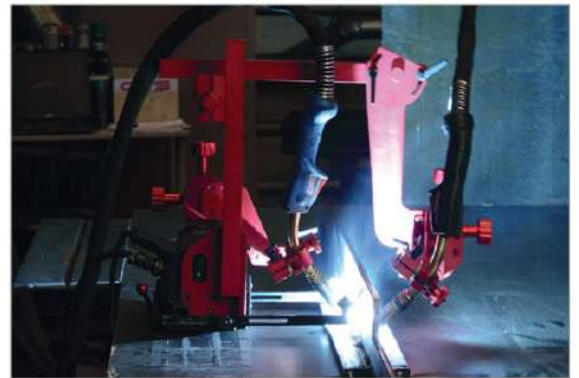
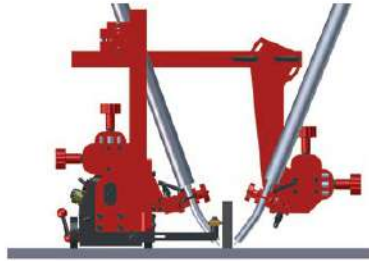

WLK-0476-20-01-00-0  
Short Rod Clamp



BLO-0466-44-01-00-0  
Magnet blocks (front)  
M5x25



BLO-0466-47-01-00-0  
Magnet blocks (front) with  
increased power M5x25



ZRZ-0466-19-00-00-0  
Torch clamp 22-35 mm



BLO-0466-45-01-00-0  
Magnet blocks (back) M6x25  
incl. additional spacer plate  
required for Gecko Battery only



BLO-0466-48-01-00-0  
Magnet blocks (back) with  
increased power M6x25

**Optional accessories for multi-surface guiding and variety of applications**



PRW-0466-65-00-00-1  
Low guide arms (set of 2 pcs)





PRW-0466-66-00-00-1  
High guide arms (set of 2 pcs)

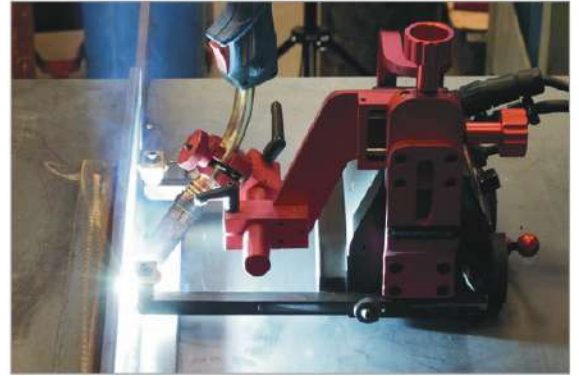

PRW-0466-41-00-00-1  
Edge following guide arms (set of 2 pcs)

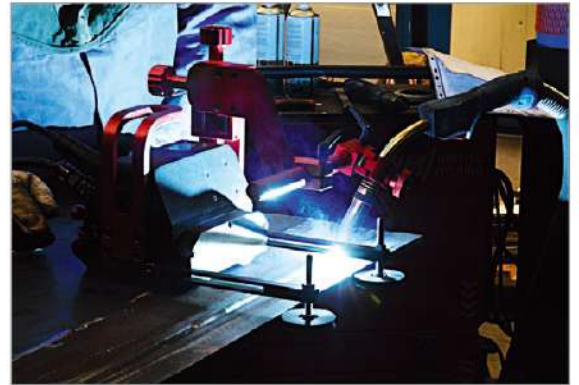
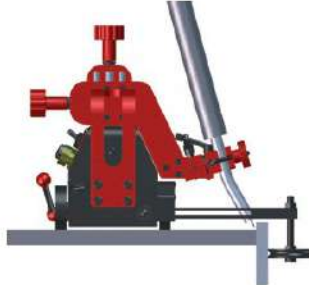

PRW-0466-42-00-00-1  
Adjustable guide arms (set of 2 pcs)



PRW-0466-52-00-00-1  
Magnet guide arms (set of 2 pcs)

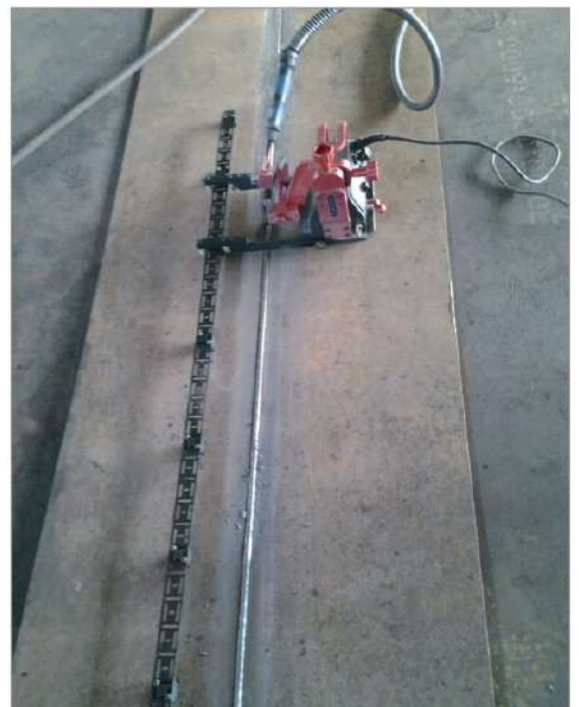

PRW-0466-50-02-00-1  
Track following guide arms (set of 2 pcs)

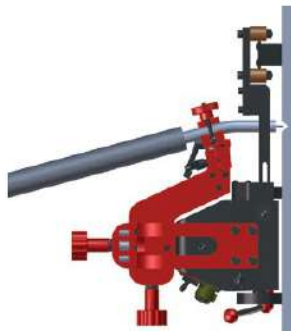

UST-0466-53-00-00-0  
Guide adjustment tool to position the track parallel to the edge

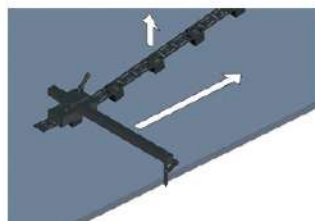



Flexible track length 185 cm (6ft) 1pc  
Minimum curvature radius of 1.0 m (3.3 ft)  
PRW-0466-50-01-01-0



Magnetic block for flexible track  
box of 10 pcs  
BLO-0466-68-00-00-0



Depending on sort of fixing units in use with flexible trackway, Gecko and Gecko HS welding tractors are suitable for applications with carbon steel, stainless steel and aluminum.

Flexible trackway length 1.88 m (6.1 ft).  
Minimum curvature radius of 1.25 m (4.1 ft)  
PRW-0466-71-00-00-0

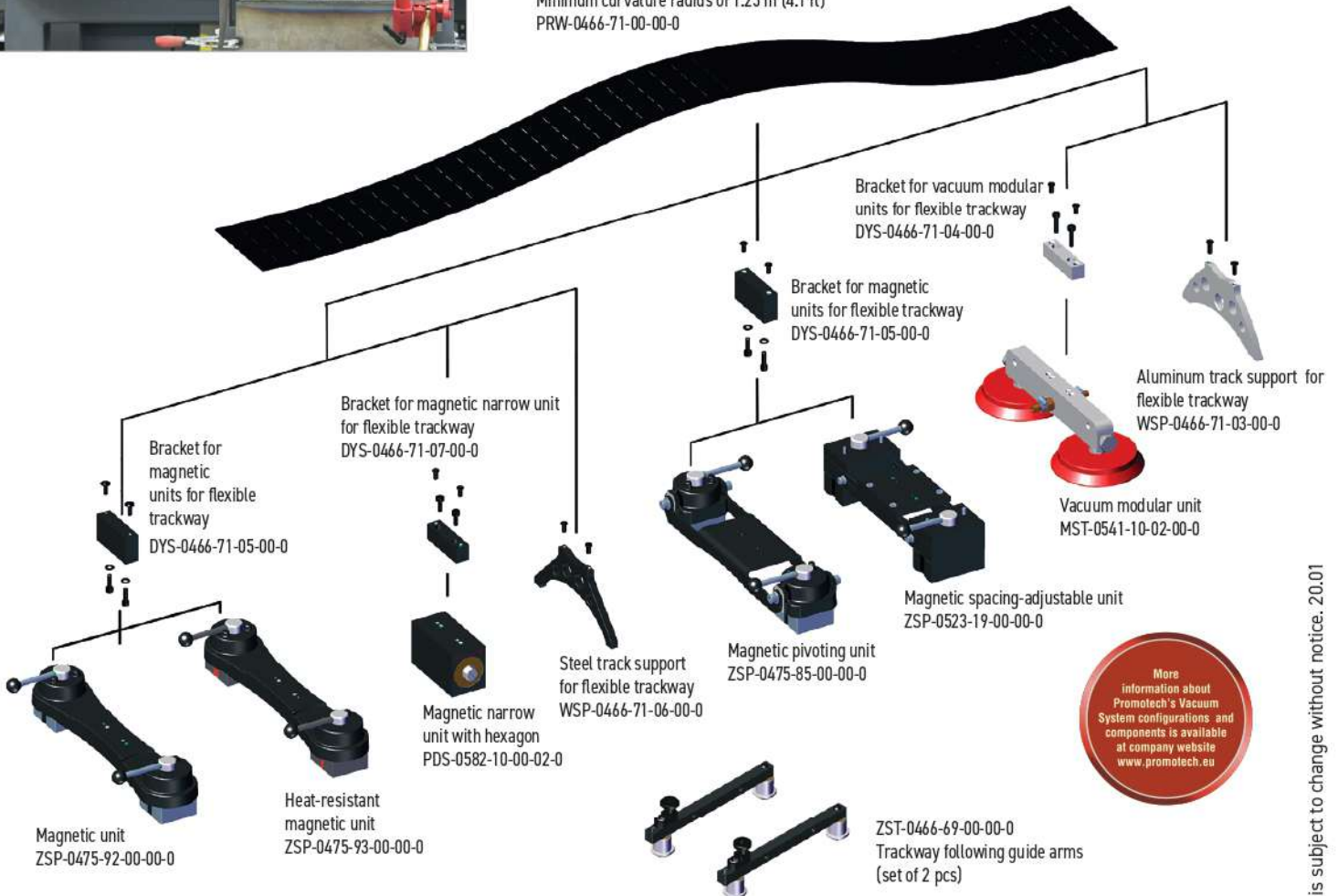

More information at [www.promotech.eu](http://www.promotech.eu)



**American Welding Society**  
Supporting Company Member

Mitglied im DVS – Deutscher Verband für  
Schweißen und verwandte Verfahren e. V.



All information is subject to change without notice. 20.01



PROMOTECH Sp. z o.o.  
ul. Elewatorska 23/1, 15-620 BIAŁYSTOK, POLAND  
tel. (+48 85) 678 34 05, fax (+48 85) 662 78 77  
marketing@promotech.eu www.promotech.eu

Your local dealer:

